

## Trumpf Type

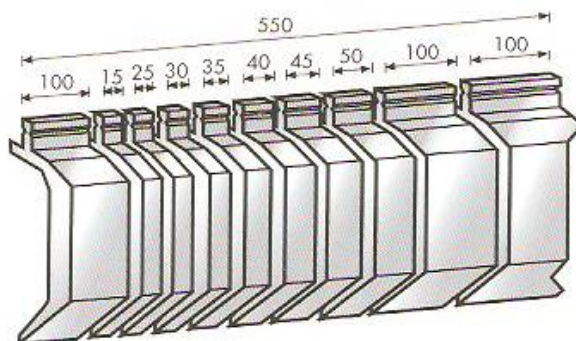

FRAZIONATURA STAI  
STANDARD SECTII  
STANDARDUNTERTI

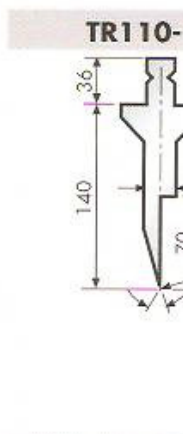
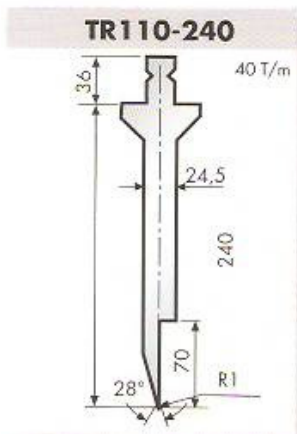
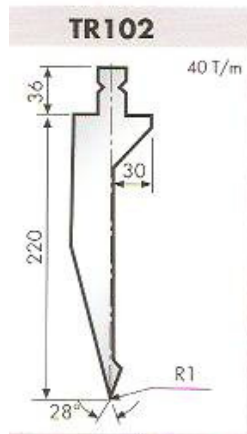
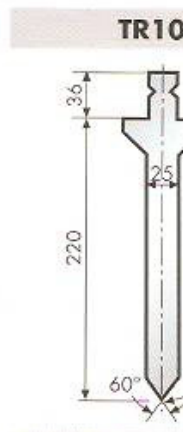
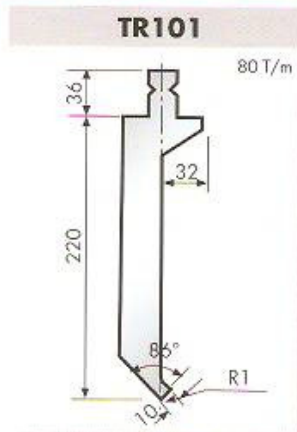
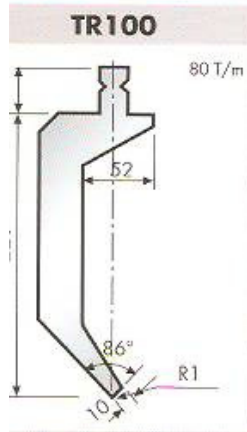

## Trumpf Type

**TM 6/30°**

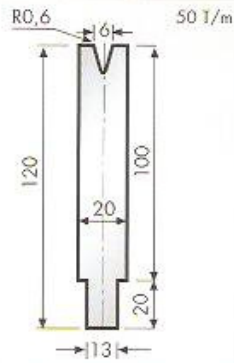

**TM 8/30°**

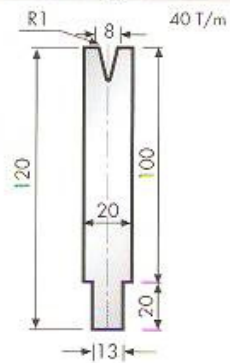

**TM 10/30°**

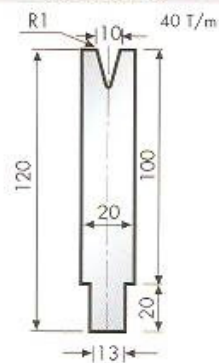

**TM 12/30°**

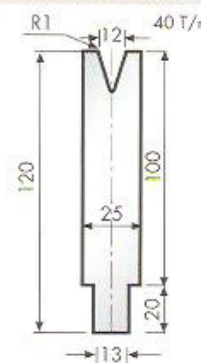

**TM 16/30°**

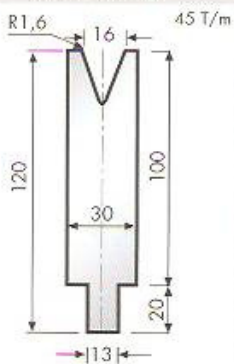

**TM 20/30°**

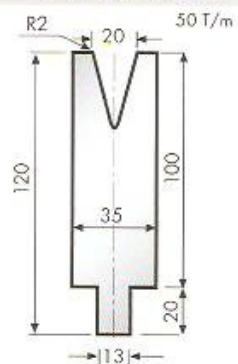

**TM 24/30°**

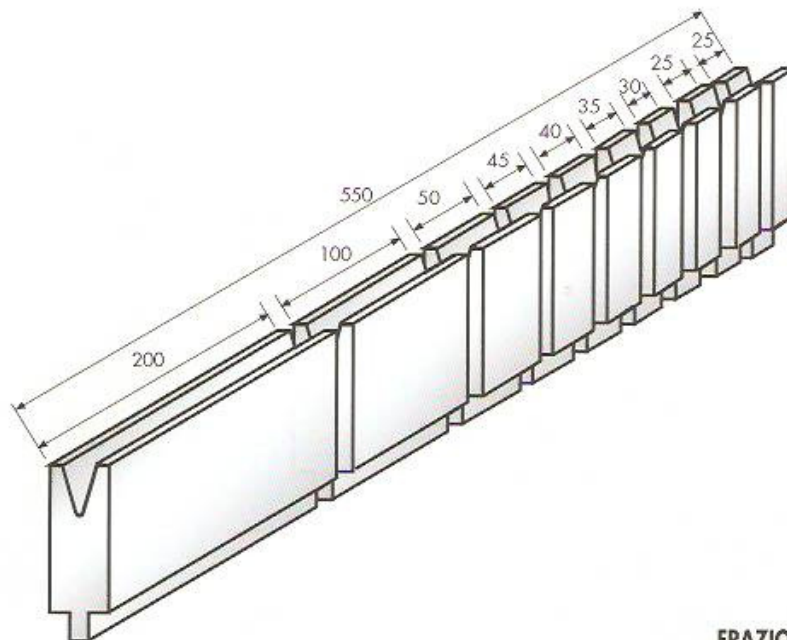
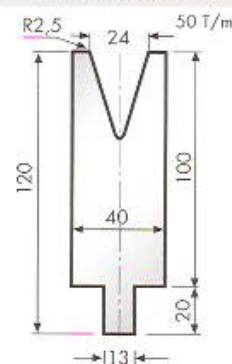

FRAZIONATURA STANDARD  
STANDARD SECTIONING  
STANDARDUNTERTEILUNG